

## Magnetic drive pumps

Chemically resistant magnetic drive pumps which can tolerate abnormal operation



The MX-F series development was based on the concept of optimum reliability under severe operating conditions and features our unique self radiation structure (PAT.PEND) as well as our well-established non contact system.

Patent

TAIWAN

Pat.Pend.

JAPAN / U.S.A. / EU / CHINA

# Chemically resistant magnetic drive pumps which can tolerate abnormal operation

The MX-F series development was based on the concept of optimum reliability under severe operating conditions and features our unique self radiation structure (PAT.PEND) as well as our well-established non contact system.

The MX-F retains excellent durability under abnormal operation such as dry running, cavitation and closed-discharge operation.

High grade materials including ETFE, are utilized as the main wetted materials.

The MX-F series is an excellent choice for reliably handling a wide range of chemicals in various manufacturing processes.



- **An improved mechanical strength design allows operation under abnormal conditions and results in reduction of running cost and maintenance cost.**
- **The adoption of a volute casing divided into two raises efficiency. (Pat.Pend.)**
- **Simply constructed, it is robust and facilitates maintenance.**
- **Fluororesin, excellent resistance to chemicals.**

**Self-radiating structure**

(International patent applied)  
Through heat-dispersion holes provided in the fixed portions of the impeller and the magnet capsule, the liquid around the spindle and the bearing is forced to circulate so that heat generated by sliding can be reduced effectively. Thus, thermal deformation and melt are prevented.  
(Except MX-F100)

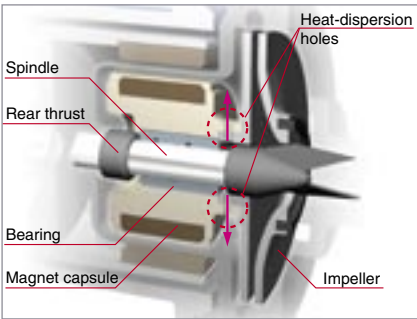

**Non-contact structure**

By installing the driving magnet and the driven magnet in an inventive way, the movement of the magnet capsule is controlled by magnetic force to prevent the rear thrust and the rear portion of the bearing coming into contact with each other continuously even during dry running. This structure reduces heat generation and secures lubricant routes.  
(Except MX-F100)

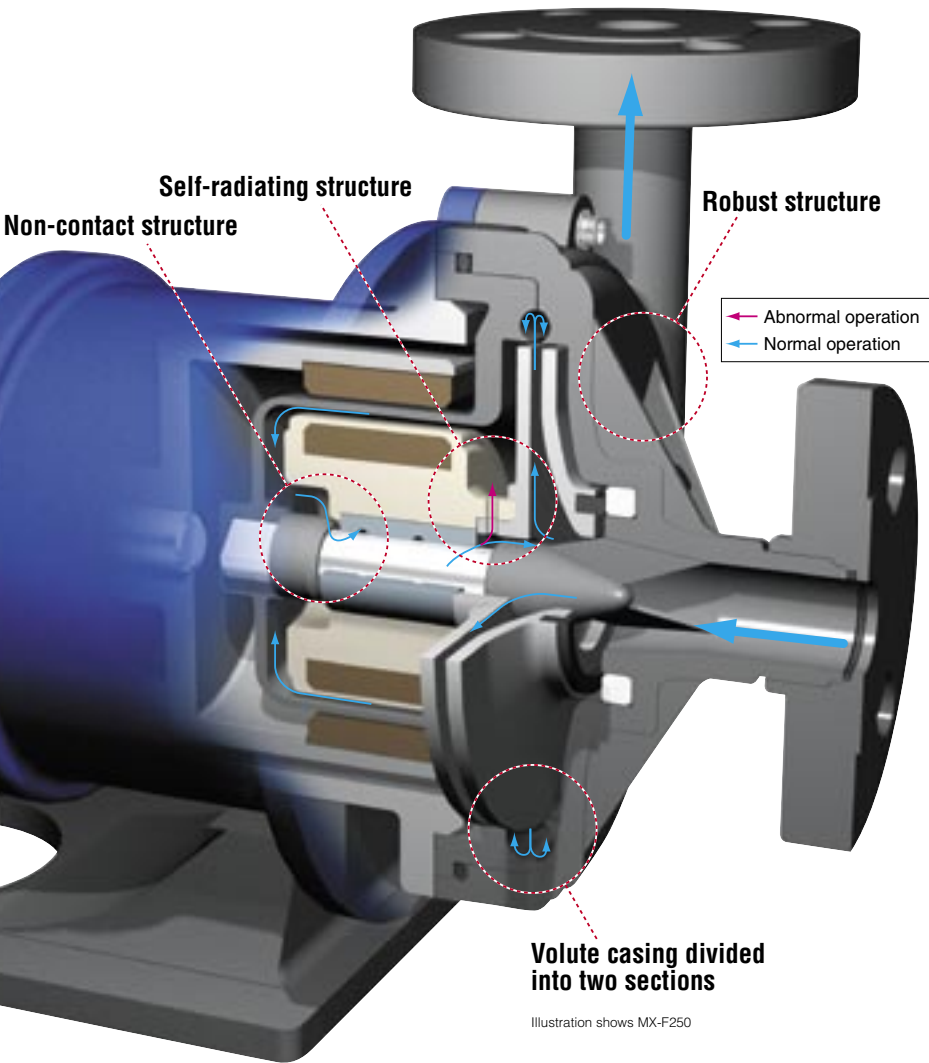

Illustration shows MX-F250

**Volute casing divided into two sections**

(International patent applied)  
The MX-F series is the first resin magnet pump which uses the pump casing divided into the front casing and the rear casing to form a vortex chamber as an ideal form. Therefore, the internal leak phenomenon, which means that the liquid getting out of the impeller returns to the pump casing and is suppressed to a minimum and the liquid is efficiently guided to the discharge port to enhance overall efficiency. (Except MX-F400)



Front casing      Rear casing

**Robust structure**

All stress bearing portions, such as the front and rear casings, are reinforced by means of ribs to improve the pressure resistance and the mechanical strength of the pump.

The bearing is not only fixed by conventional press fit but is also sandwiched between the abutting portion in the depth of the magnet capsule and the rear end of the impeller to improve its reliability under high temperature.

(Except MX-F100)

MX-F402 and F403 models: an unplugging preventive lock pin is adopted for ensuring more steady securing.



Front casing of type MX-F100 and MX-F402/403



MX-F403

MX-F401

MX-F250

## Wet end materials

### ■MX-F100

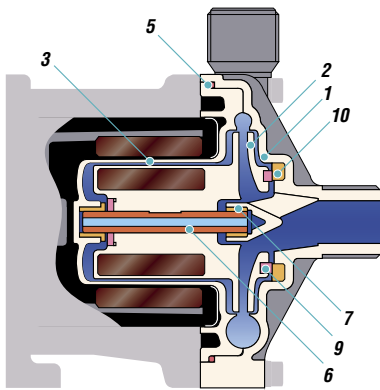

### ■MX-F250 to F401

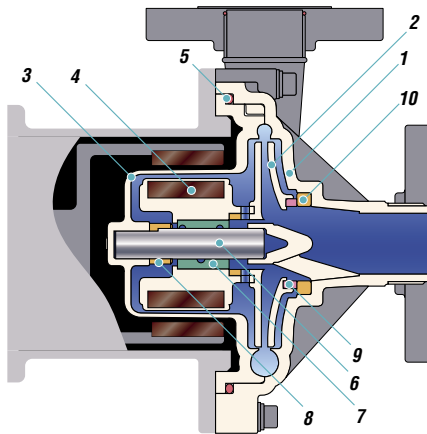

### ■MX-F402 to F403

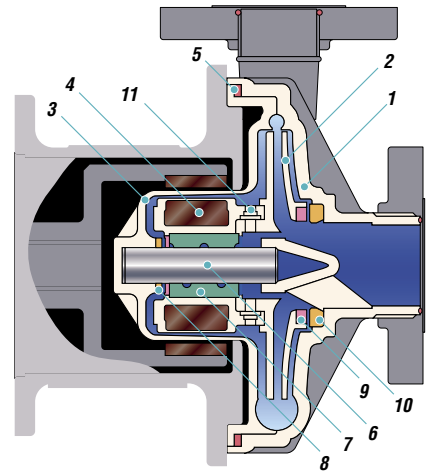

Model	MX-F100		MX-F250 to F401			MX-F402 to F403		
	RV	KV	CFV	RFV	KKV	CFV	RFV	KKV
1 Front casing	CFRETFE		CFRETFE			CFRETFE		
2 Impeller	CFRETFE		CFRETFE			CFRETFE		
3 Rear casing	CFRETFE		CFRETFE			CFRETFE		
4 Magnet capsule	CFRETFE		CFRETFE			CFRETFE		
5 O ring <small>Note 1</small>	FKM		FKM			FKM		
6 Spindle	High purity alumina ceramic	SiC	Alumina ceramic		SiC	Alumina ceramic		SiC
7 Bearing	PTFE	SiC	Carbon	PTFE	SiC	Carbon	PTFE	SiC
8 Rear thrust	High purity alumina ceramic	SiC(Front & Rear)	CFRETFE			CFRPFA		
9 Mouth ring	PTFE	-	PTFE		SiC	PTFE		SiC
10 Thrust/Liner ring	High purity alumina ceramic	-	Alumina ceramic		SiC	Alumina ceramic		SiC
11 Lock pin	-		-			CFRETFE		

Note 1: O-ring made of AFLAS® and EPDM are also available

### Precautions for pump selection

1. The performance curves on this catalogue are based on clean water of 20 °C.

2. For the MX-F250, select a proper impeller size according to specific gravity. Always keep 5 - 10% allowance to motor output.

Applicable motor output

$$Sp \times S.G \times (1.05 - 1.1) \leq \text{Motor output Allowance}$$

3. The magnetic drive pump is not durable for a long time in closed-discharge operation. Always keep the minimum flow.

Minimum flow

MX-F100, 250, 251, 400, 401: 10 L/min  
MX-F402, 403: 20 L/min

4. NPSH validation

Observe the following for the prevention of cavitation.

$$NPSHa \geq NPSHr + 0.5 \text{ m Allowance}$$

$$NPSHa = 10^6 \times \frac{(Pa - Pv)}{\rho g}$$

5. Maximum withstand pressure

MX-F100: 0.19MPa      MX-F400: 0.22MPa  
MX-F250: 0.25MPa      MX-F401: 0.28MPa  
MX-F251: 0.33MPa      MX-F402: 0.43MPa  
MX-F403: 0.43MPa

NPSHa: Net Positive Suction Head Available (m)  
NPSHr: Net Positive Suction Head Required (m)  
Pa: Pressure on the suction liquid level (MPa) (Absolute pressure)  
Pv: Pressure of saturated vapor (MPa)  
hs: Static suction head (m)  
hfs: Suction pipe resistance (m)  
 $\rho$ : Liquid density (kg/m<sup>3</sup>)  
g: G-force (9.8m/sec<sup>2</sup>)



MX-F100

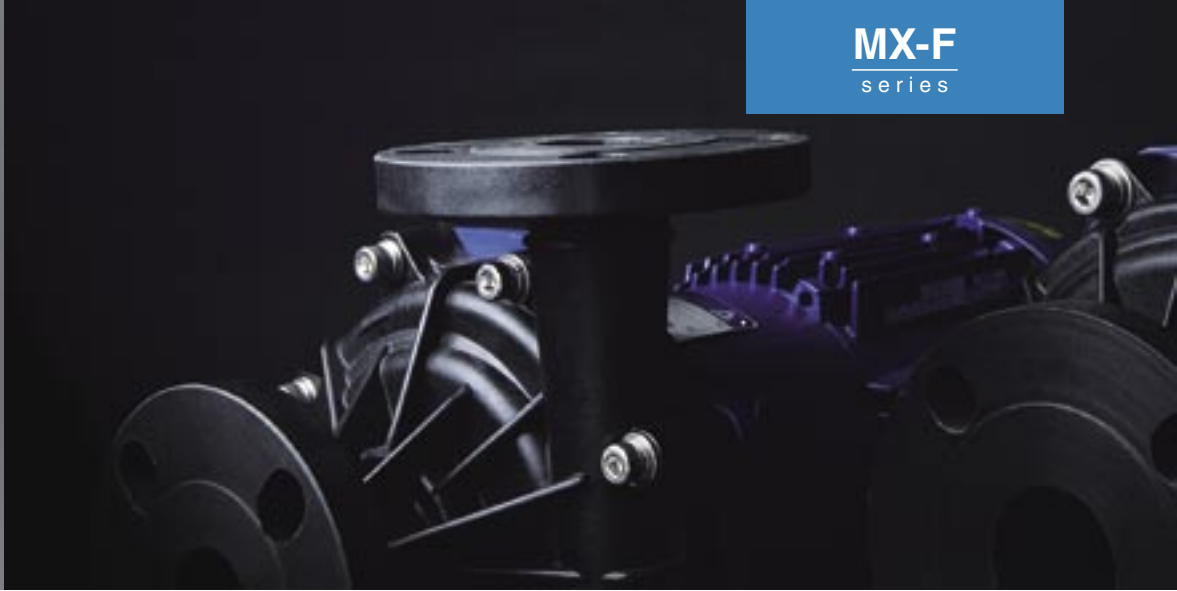

## Pump identification

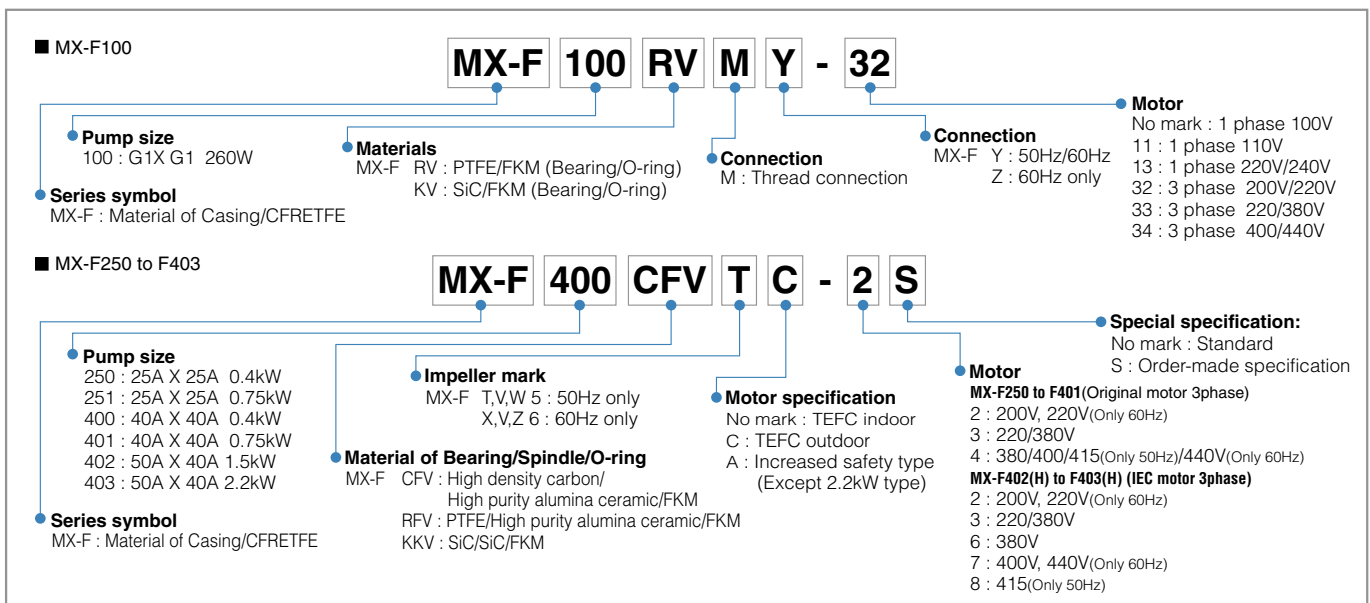

## Specifications

50/60Hz

Model	Connection Suction X Discharge	Limit of specific gravity	Standard capacity L/min - m	Maximum capacity L/min	Motor kW	Mass kg
MX-F100 Y	G1 x G1	1.9 / 1.2	70 - 5.8 / 9.0	110 / 125	0.26	8.5
MX-F100 Z	G1 x G1	- / 1.8	70 - - / 5.8	- / 110	0.26	8.5
MX-F250 T/X	25A x 25A	1.2	50 - 11.7 / 11.8	150	0.4	14.5
MX-F250 V/Y	25A x 25A	1.5	50 - 9.1 / 9.5	140	0.4	14.5
MX-F250 W/Z	25A x 25A	1.8 to 2.0	50 - 6.4 / 7.5	130	0.4	14.5
MX-F251 T/X	25A x 25A	1.2	80 - 16 / 17	150	0.75	19.5
MX-F251 V/Y	25A x 25A	1.5	80 - 12.5 / 14.5	150	0.75	19.5
MX-F251 W/Z	25A x 25A	1.8 to 2.0	80 - 9 / 11.5	120 / 140	0.75	19.5
MX-F400 T/X	40A x 40A	1.2	100 - 10.1 / 9.3	250	0.4	14.5
MX-F400 V/Y	40A x 40A	1.5	100 - 8.1 / 7.6	230	0.4	14.5
MX-F400 W/Z	40A x 40A	1.8 to 2.0	100 - 5.5 / 6.3	210	0.4	14.5
MX-F401 T/X	40A x 40A	1.2	150 - 12.8 / 12.6	270	0.75	19.5
MX-F401 V/Y	40A x 40A	1.5	150 - 10.8 / 10.4	260	0.75	19.5
MX-F401 W/Z	40A x 40A	1.8 to 2.0	150 - 8.1 / 6.9	230	0.75	19.5
MX-F402 T/X	50A x 40A	1.2	200 - 18.3 / 18.5	440	1.5	31.5
MX-F402 V/Y	50A x 40A	1.5	200 - 16 / 15.2	430	1.5	31.5
MX-F402 W/Z	50A x 40A	1.8 to 2.0	200 - 12.5 / 11.7	400	1.5	31.5
MX-F403 T/X	50A x 40A	1.2	250 - 22.8 / 23.1	510	2.2	34
MX-F403 V/Y	50A x 40A	1.5	250 - 19.4 / 19.2	500	2.2	34
MX-F403 W/Z	50A x 40A	1.8 to 2.0	250 - 15.3 / 14.7	480	2.2	34

Note 1) The specific gravity limit values shown above are with maximum discharges. The specific gravity limit varies with the discharge. For details, please contact us.

### Common specifications

- Range of liquid temperature : 0 to 80°C (10 to 80°C in case AFLAS® O-rings are used.)
- Range of ambient temperature : 0 to 40°C.

# Performance curves

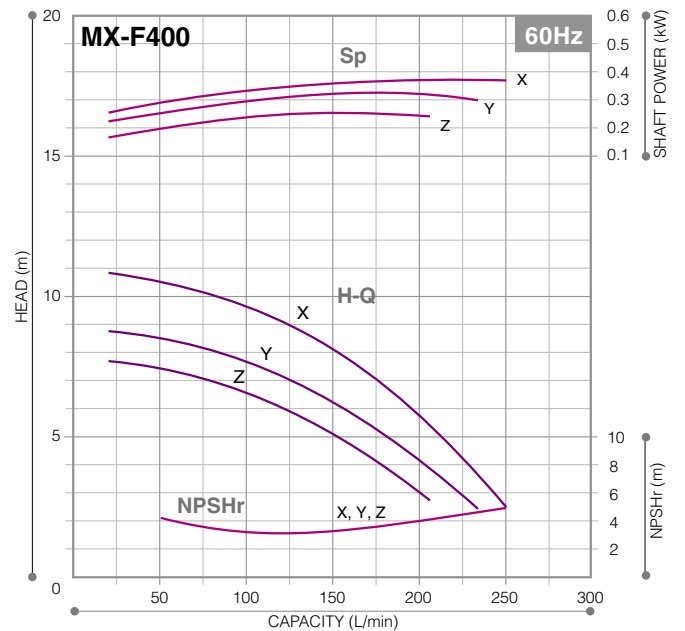
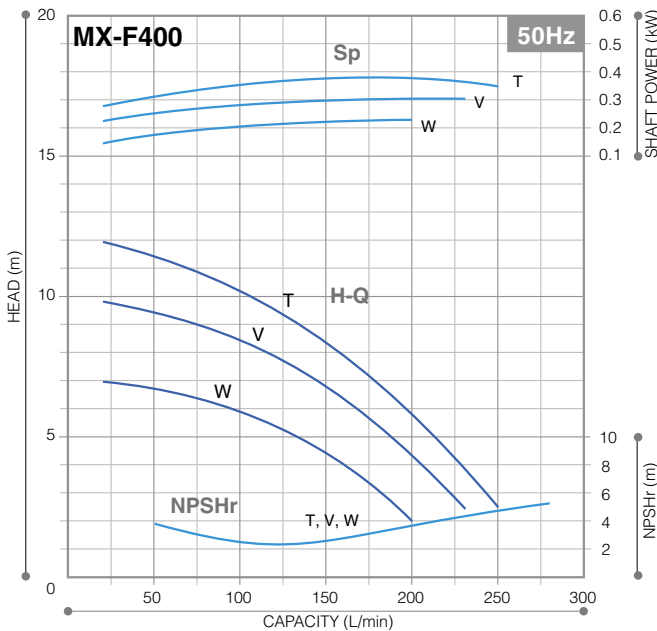
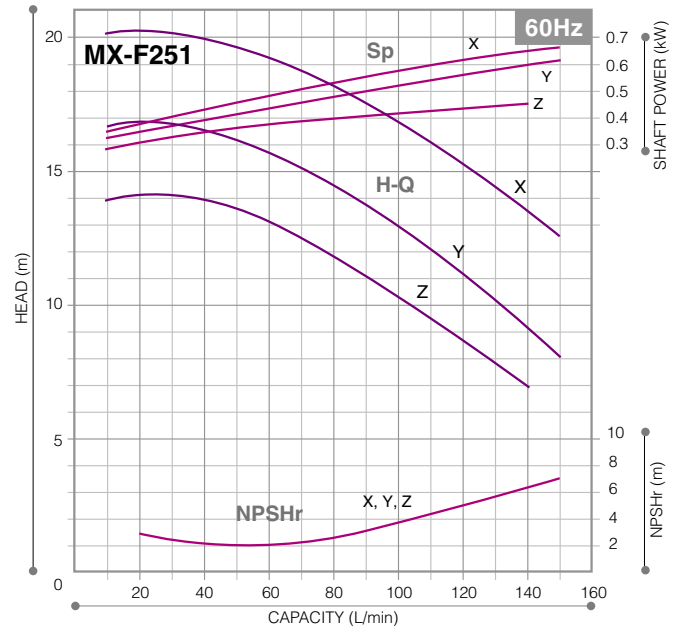
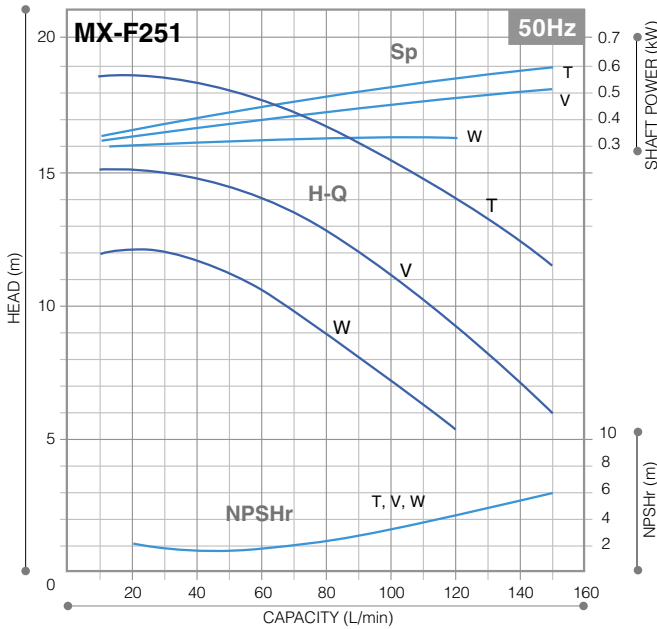
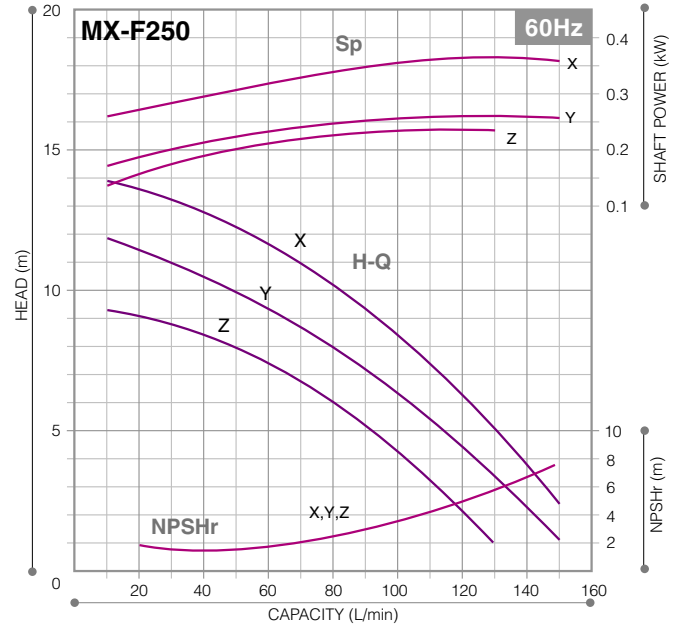
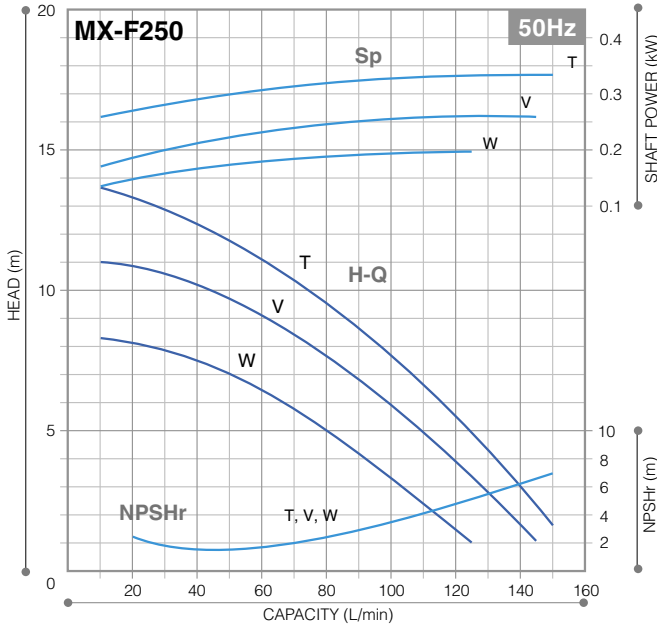

**Performance curves**

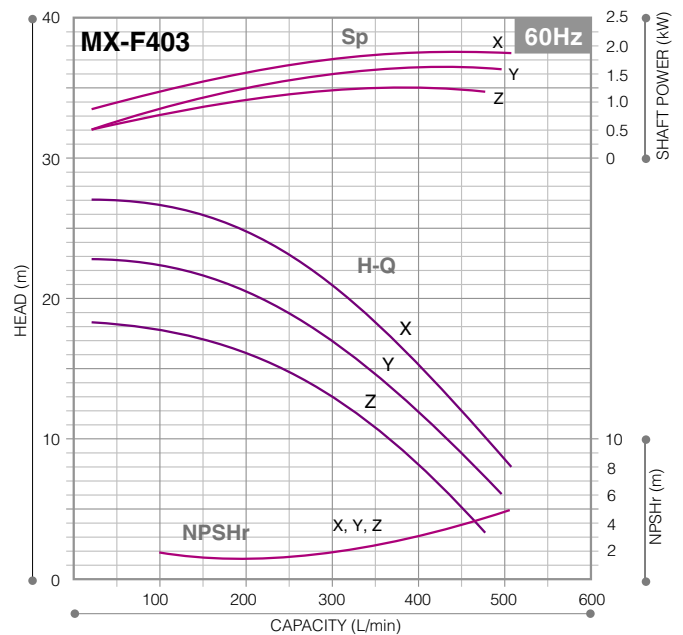
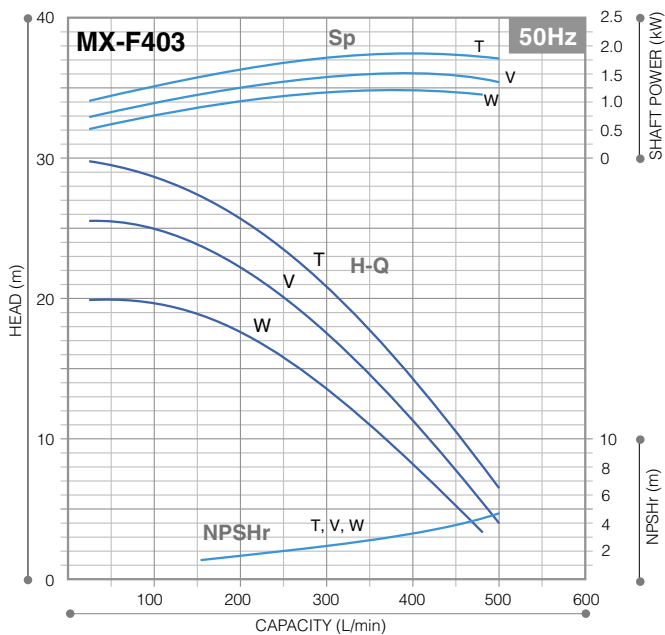
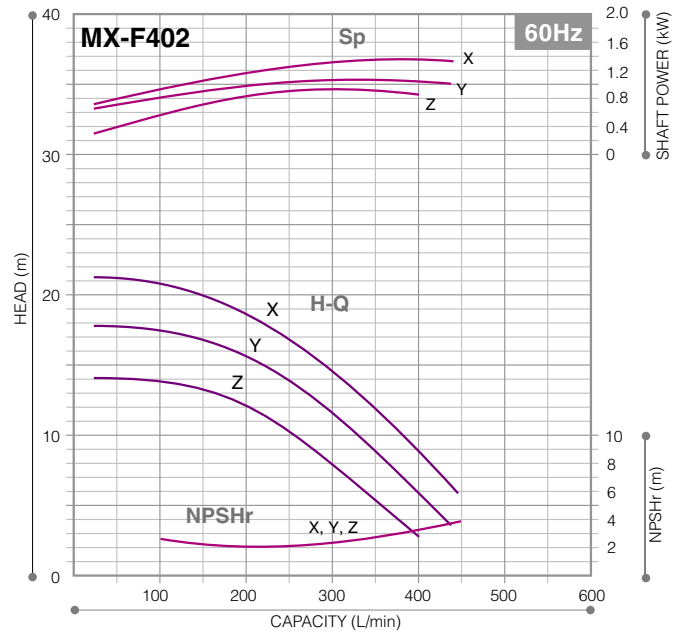
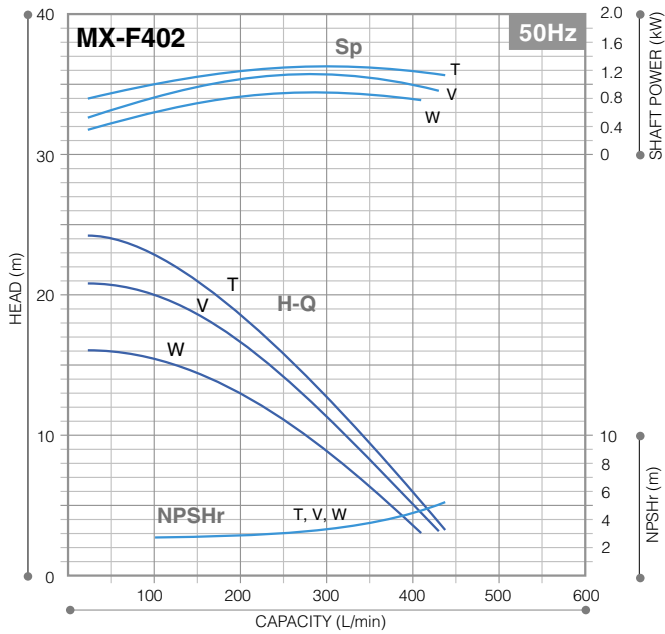
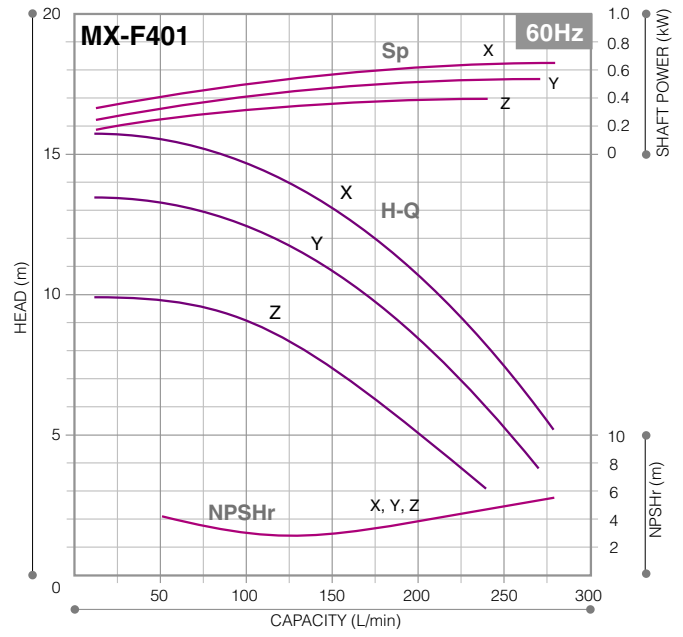
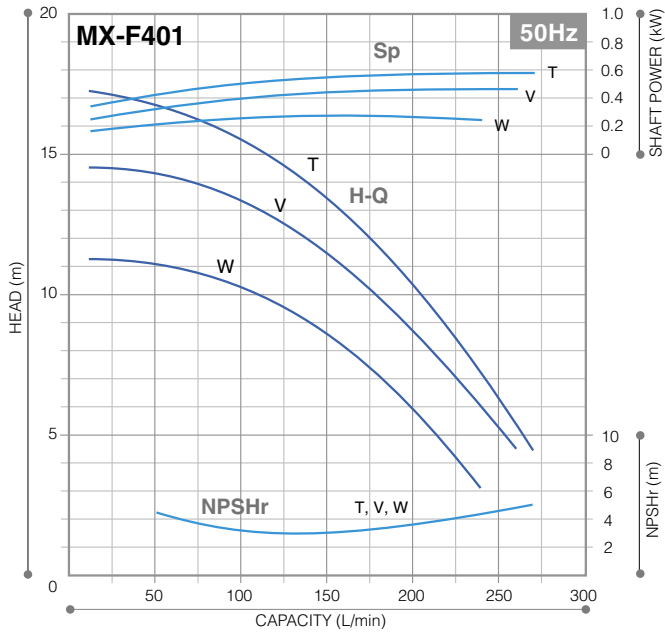

## Performance curves

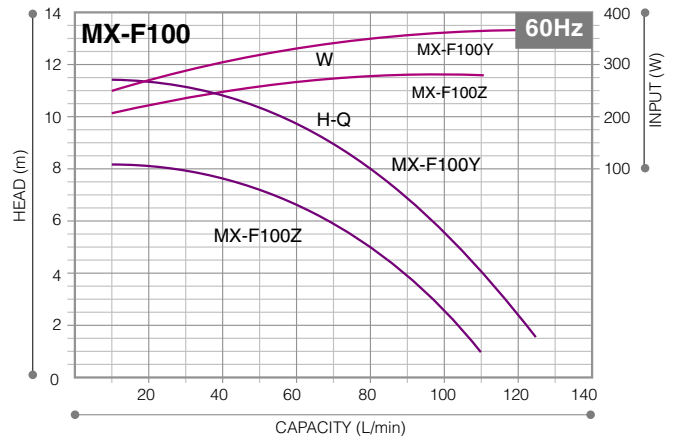
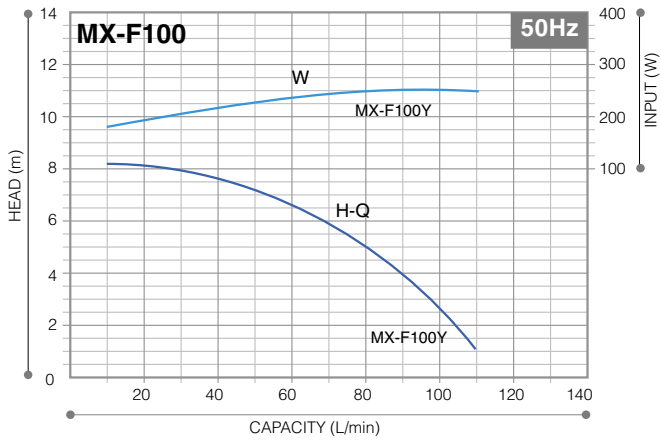

## Dimensions

### ■ MX-F100

### ■ MX-F250 to F401

### ■ MX-F402, F403

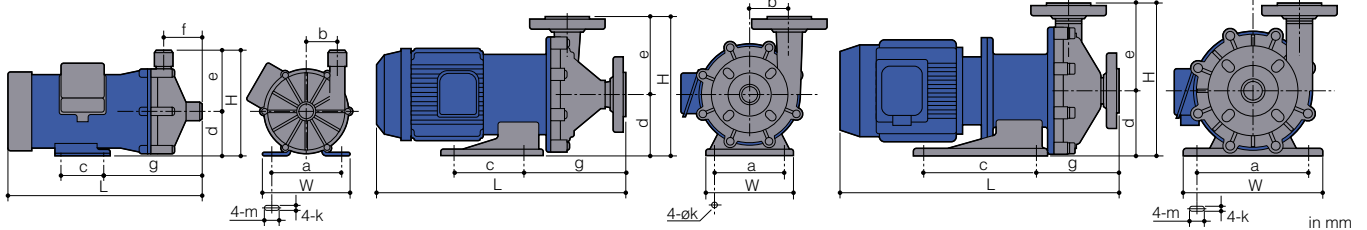

Models	W	H	L	a	b	c	d	e	f	g	k	m
MX-F100	150	175	319.5	110	51	70	75	100	65	162	9	27
MX-F250	160	255	408	130	65	130	115	140	90	163	12	—
MX-F251	160	255	444	130	65	130	115	140	90	163	12	—
MX-F400	140	225	408	110	54	98	95	130	87	150	12	—
MX-F401	160	255	457	130	72	130	115	140	103	184	12	—
MX-F402 to F403	260	280	516	208	80	200	120	160	89	157	14	36

## Optional accessories

### Iwaki dry running protector DR series

Model DR is electric current sensing type dry running protector. It detects the decreased load current (lower limit) to stop the pump when it runs dry or runs with air sucking in. It can detect over-load, too.

- Current figure to be set is indicated on LCD.
- Both top/bottom figures can be set.  
Top: Over-load  
Bottom: Dry running, air sucking-in operation, operation with suction side closed
- Built-in current transformer
- DIN rail mounting
- It is unable to use DR when inverter is employed in the system.



### Specification

50/60Hz

Model	DR-10, DR-20	
Motor power	200 to 240V three phase	380 to 440V three phase
Applied motor	0.4 to 7.5kW	0.75 to 15kW
Power control	100 to 240V single phase	
Power	V	100V ±10% single phase
	Input	200 to 240V ±10% single phase
Detective current	0.5 to 32.0A	
Current transformer(CT)	Built-in	
Outer dimension	D80 X W153 X H122	

### Union joint (Option)

Special purpose union joints are available.

Material : PVC/Heat resistant PVC

