

# Magnetic drive pumps

## Magnetic drive process pump resistant to dry run damage



The MDM Series of Magnetic drive process pumps have wetted parts made of fluoro resin. Natural PFA and CFRETFE being standard materials of construction.

# Magnetic drive process pump resistant to dry run damage

The MDM Series of Magnetic drive process pumps have wetted parts made of fluoro-resin. Natural PFA and CFRETFE being standard materials of construction. The MDM features a unique mechanism which gives a greatly improved performance against dry running (Non contact system). Applications cover a wide range of chemical process duties from acid to alkali together with high purity chemicals for the semiconductor industry.

## Unique design prevents dry running

(Non contact system)

The pump design features a mechanism to withstand dry running. High magnet power of the rare earth magnets prevents the magnet capsule coming into contact with the thrust ring of the rear casing, thus preventing melting of fluoro-resin components due to heat generation. This greatly improves resistance against dry running in comparison with conventional magnetic drive pumps made of fluoro-resin.

Note: Only CF type (fitted with high density carbon bearing) can cope with dry running. Dry running is not permitted in the case of KK type.

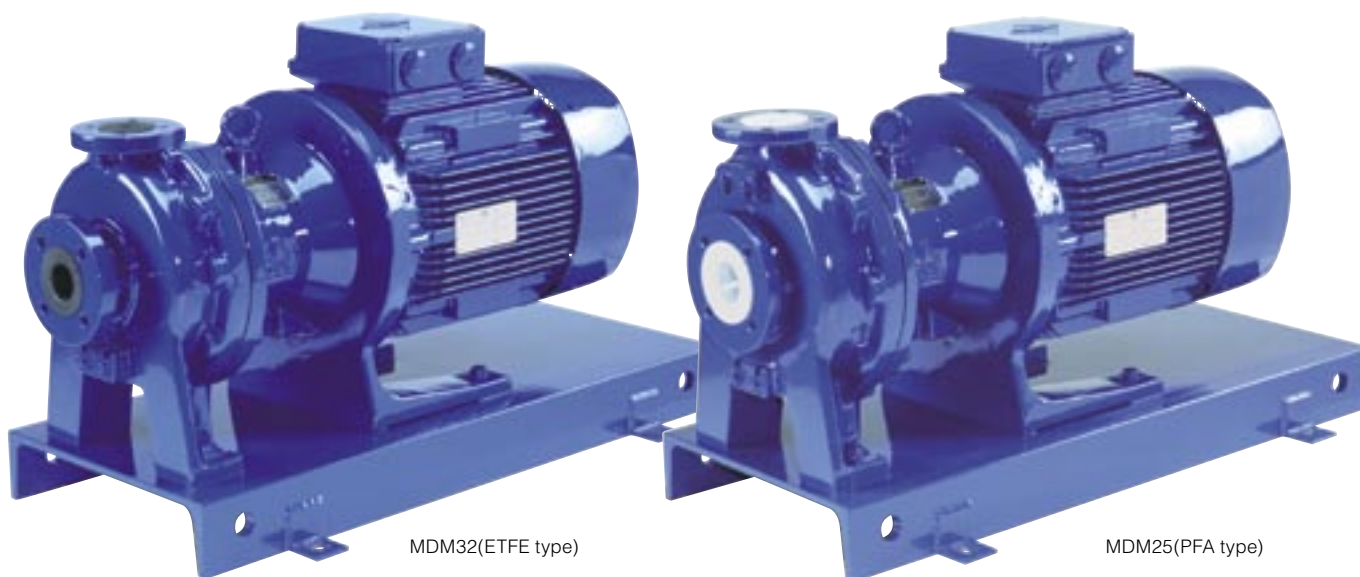
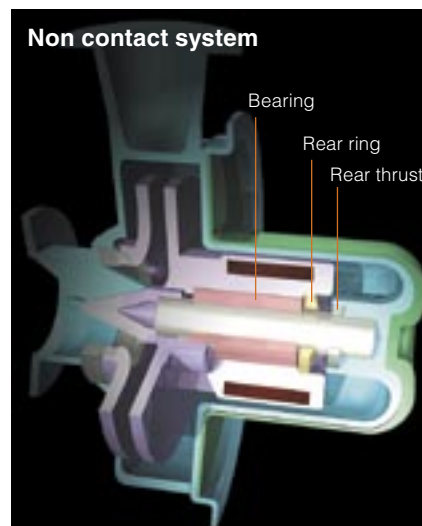

### ETFE and PFA available in standard models

Carbon fibre reinforced ETFE (CFRETFE) and PFA linings can be supplied to meet many varying duties. PFA being a natural unfilled material generates fewer contaminants and makes it ideally suited for transfer of high purity chemicals.

Note: Long coupling type is only PFA version.

### Highly durable structure

A ductile cast iron shell adds strength and durability to the outer peripheral surfaces of the fluoro-resin pump module. The rear casing which is placed under the highest stress is protected by a rear casing cover made from fibre reinforced plastic. This gives sufficient strength and eliminates the eddy current loss caused by the rotating magnetic field. Should it come into contact with the drive magnet unit, no spark would be generated and a high level of safety would be maintained.

### Back pullout system

In order to facilitate inspection and maintenance, this series employs the back pullout system. This enables one to conduct inspections internally and replace parts without removing piping. The pump is designed to include safety measures that can prevent the liquid from leaking when the foot support (bracket) is pulled back.

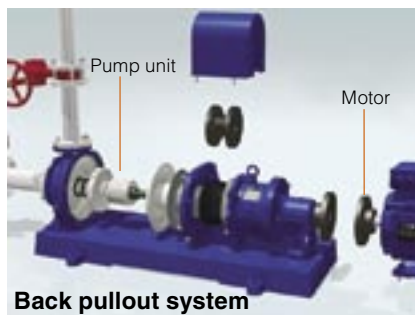

### Compliance with ISO standards (ISO2858/DIN EN22858)

The pump with a common base comply with ISO Standards in regard to piping connection.

Note 1: For compatibility in size with other series of our magnet pumps, please call us.

Note 2: ANSI and JIS standards are also available.

For details, please call us.

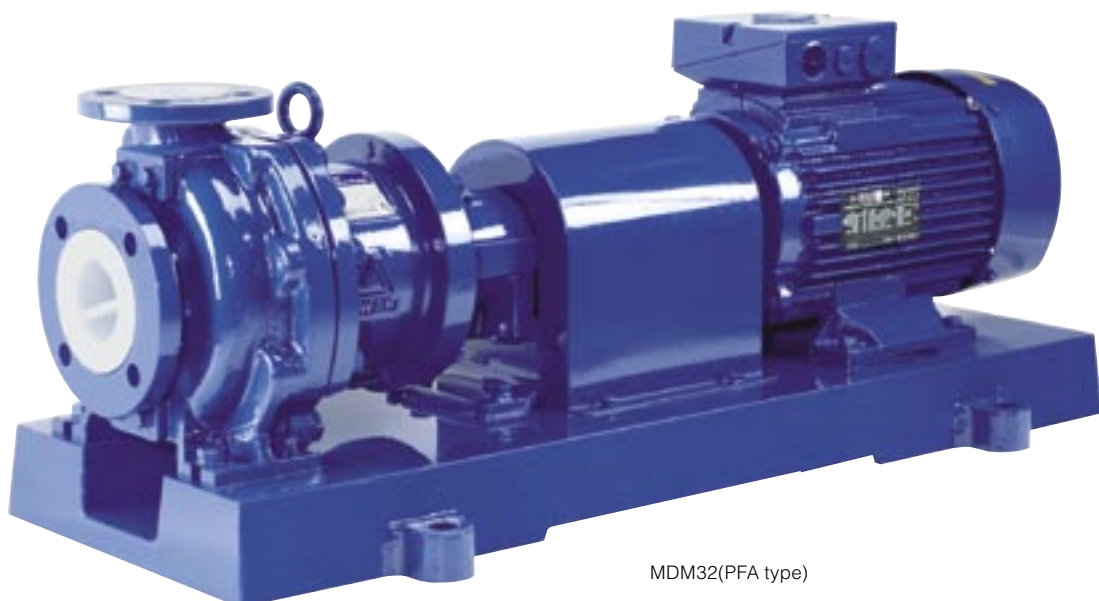

MDM32(PFA type)

# Construction

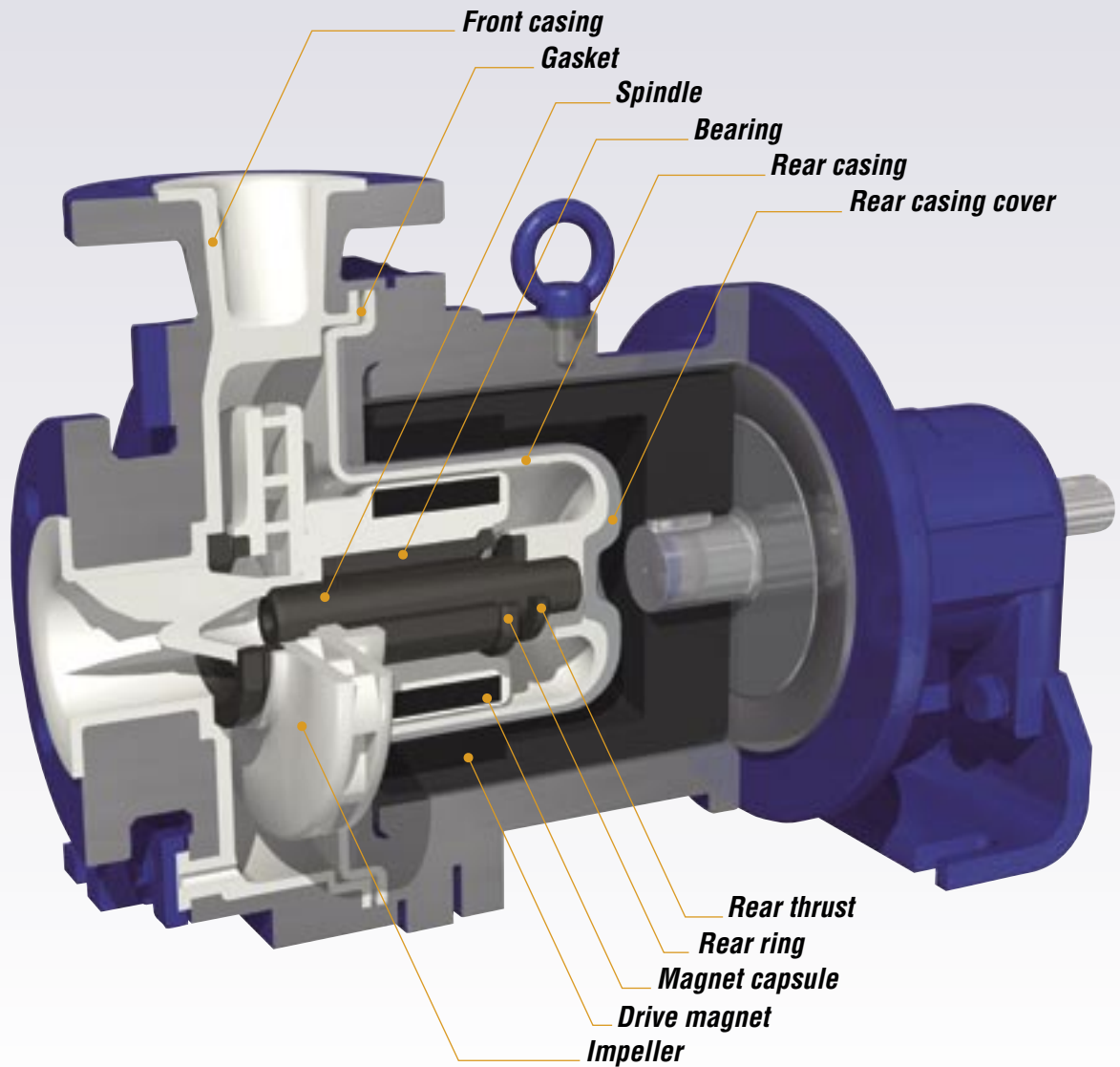

## Wet-end materials

	Materials	ECF	EKK	PKK
1	Front casing	CFRETFE	SiC	PFA
2	Rear casing (Note 1)			
3	Impeller			
4	Magnet capsule			
5	Bearing	High density carbon	SiC	SiC
6	Spindle	High purity alumina ceramic		
7	Liner ring	PTFE (with Filler)		
8	Mouth ring	High purity alumina ceramic		
9	Rear ring	PTFE (with filler)	PTFE	
10	Rear thrust	PTFE (with filler)		
11	Gasket	PTFE		

Note 1: Rear casing of MDM25-3 and MDM32-2 for over 80°C application is special construction (Patent).

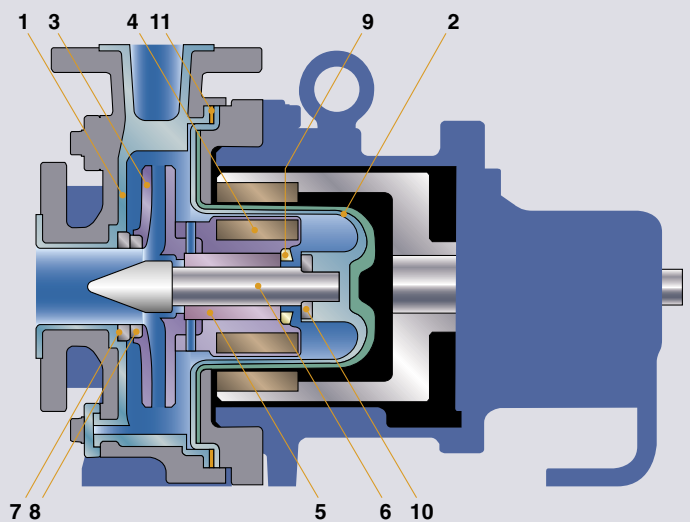



**Front casing ETFE type**

A moulding made of carbon fibre reinforced ETFE (CFRETFE). It has both a high mechanical strength and excellent corrosion resistance. The outer peripheral surfaces are reinforced by a ductile cast iron outer casing in order to achieve excellent strength and durability.



ETFE type

**Front casing PFA type**

The ductile cast iron casing is a one-piece moulding with natural PFA fluororesin lining integrally moulded. This construction is free from contamination and ideal for transfer of clean liquids or with less particle generation.



PFA type

Note: For lower duty MDM25-1 type a different moulding method is used.

**Impeller**

Closed type impellers are designed to give high efficiency. To ensure positive fixing of impeller to magnet capsule a spline system together with a pin fixing is employed. This prevents the impeller from moving axially off the magnet capsule (Patented). MDM25 and 32 models now have impellers capable of reaching max. heads of 74 meters (50Hz) to widen the range of application.



ETFE type



PFA type

**Rear casing  
Rear casing cover**

The fluororesin rear casing is strengthened by the outer rear casing cover which is manufactured in fibre reinforced plastic capable of withstanding a pressure of 1 MPa.

(Note: For long coupling type, maximum pressure is 1.6MPa.)

This structure also eliminates any eddy current losses due to a rotating magnetic field. It also prevents sparks from being produced should the rear casing come into contact with the drive magnet unit.

A newly developed triple-layer casing (Patented) is used for the high head models MDM25-3 and 32-2 when liquid temperature exceeds 80°C. This new design allows a rated 1.6MPa casing pressure overall temperature range. Since the front and rear casing are bolted together from the front casing side liquid does not leak out when the foot support (bracket) is pulled back.



PFA type with rear casing cover

**Rear ring**

As a precaution against abnormal running, for example cavitation or air entering the pump where the magnet capsule could move axially backwards a rear ring and thrust ring have been incorporated. The rear ring is designed to give minimal heat generation from contact and therefore heat generation is greatly reduced compared to conventional designs. This prevents surrounding fluororesin from melting. (Patented)

**Rear Thrust**

The rear thrust withstands axial loads encountered from abnormal operation, it also minimizes heat generation.

**Magnet capsule**

High magnet strength rare earth magnets are totally encapsulated with fluororesin mouldings. Magnets are small and lightweight which increases the efficiency of the pump. Taking advantage of the high magnetic strength its new design of "Non contact system" was developed to protect pump from dry running. This enables us to offer pumps that will withstand dry running operation. (CF type only)



ETFE type

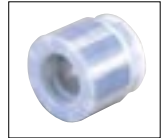

PFA type

**Spindle**

Both ends of the spindle are supported by the front casing and the rear casing (the fixed spindle type). There are two types of spindle; one is made of high purity alumina ceramic and the other made of SiC.



SiC type High purity alumina ceramic type

**Bearing**

Two standard bearing materials are available. SiC gives high resistance to abrasion. High density carbon withstands dry running operation. Bearings can be individually replaced.



SiC type High density carbon type

**Gasket**

A PTFE shrouded gasket is used to enhance sealing performance and corrosion resistance.

# Specifications

## 2 pole motor type

50Hz

Model	Pump size Suction X Discharge	Impeller size	Capacity L/min	Head m	Motor kW
<b>MDM25-1</b> (Impeller range 1)	40mm X 25mm	165	100	35.5	1.5 or 2.2
		160		33.5	
		150		29.0	
		140		25.0	
		130		20.5	
<b>MDM25-2</b> (Impeller range 2)	40mm X 25mm	195	100	50.5	4.0, 5.5 or 7.5
		190		49.0	
		180		44.5	
		170		38.0	
		160		34.5	
<b>MDM25-3</b> (Impeller range 3)	40mm X 25mm	225	100	74.0	5.5, 7.5, 11 or 15
		220		69.0	
		210		61.0	
		200		55.0	
		190		48.5	
<b>MDM32-1</b> (Impeller range 1)	50mm X 32mm	165	208	35.0	4.0, 5.5 or 7.5
		160		32.5	
		150		28.5	
		140		25.0	
		130		20.5	
<b>MDM32-2</b> (Impeller range 2)	50mm X 32mm	120	208	17.0	5.5, 7.5, 11 or 15
		225		70.0	
		220		67.5	
		210		60.0	
		200		54.0	
<b>MDM40-1</b>	65mm X 40mm	190	417	47.0	4.0, 5.5 or 7.5
		180		41.5	
		170		38.0	
		160		32.0	
		165		33.0	
<b>MDM50-1</b>	80mm X 50mm	160	833	31.0	5.5, 7.5, 11, 15
		150		27.0	
		140		22.5	
		130		18.0	
		120		15.0	

Note1: For long coupling type, head is 34.5m.

Note2: For long coupling type, head is 32.5m.

## 4 pole motor type

50Hz

Model	Pump size Suction X Discharge	50Hz			Motor kW
		Impeller size	Capacity L/min	Head m	
<b>MDM25-2</b> (Impeller range 2)	40 mm X 25 mm	200	50	12.0	1.5, 2.2, 4.0
<b>MDM25-3</b> (Impeller range 3)	40 mm X 25 mm	225	50	15.0	1.5, 2.2, 4.0, 5.5
<b>MDM32-1</b> (Impeller range 1)	50 mm X 32 mm	170	200	7.5	1.5, 2.2, 4.0
<b>MDM32-2</b> (Impeller range 2)	50 mm X 32 mm	225	200	15.0	1.5, 2.2, 4.0, 5.5
<b>MDM40-1</b>	65 mm X 40 mm	170	300	7.0	1.5, 2.2, 4.0
<b>MDM50-1</b>	80 mm X 50 mm	170	500	8.0	1.5, 2.2, 4.0, 5.5

## Common Specifications

• Temperature range of liquid handled	ETFE type : -20 to 105°C, PFA type : -20 to 150°C	Note1	• Allowable maximum pressure	1.0 MPa (All long coupling type, MDM25-3 and MDM32-2 are 1.6MPa.)
• Allowable slurry (KK type only)	Please contact us.		• Standard color of paint	Ultra marine blue RAL5002

Note1: Please contact us when handling liquid temperature is outside range of 0°C to 120°C.

Should your requirement be beyond the specs. shown in this catalog, please contact your nearest Iwaki distributor.

## Pump identification

**MDM 40 - 150 1 E KK F 075 I - D 2 H**

- Pump size** (Suction X Discharge)
  - 25: 40mm X 25mm
  - 32: 50mm X 32mm
  - 40: 65mm X 40mm
  - 50: 80mm X 50mm
- Wet-end main material**
  - E: CFRETFE
  - P: PFA
- Type of motor**
  - C: Long coupling type
  - F: Flange motor
- Impeller size**
  - 100mm to 225mm
- Impeller range**
  - 1, 2, 3
- Material of Bearing / Spindle**
  - KK: SiC/SiC
  - CF: High density carbon/ High purity alumina ceramic
- Motor output**
  - 015: 1.5kW 022: 2.2kW 040: 4.0kW 055: 5.5kW
  - 075: 7.5kW(2P) 110: 11kW(2P) 150: 15kW(2P)
- Special code**
  - H: 80 to 120°C (Applicable model: Flange motor type: MDM25-3, MDM32-2 All sizes of long coupling type)
  - T: 120 to 150°C
- Special version**
  - A: Without drain + With base
  - S: Without drain + With base + Special version
  - D: With drain + With base
  - X: With drain + With base + Special version
  - B: Without drain + Without base
  - Y: Without drain + Without base + Special version
  - E: With drain + Without base
  - Z: With drain + Without base + Special version
- Motor pole**
  - 2: 2 pole 4: 4 pole
- Standard for pipe connection and motor**
  - I: ISO flange + IEC motor J: JIS flange + JIS motor

Note: Long coupling type is designed for 50 cycle area.

## Performance curves

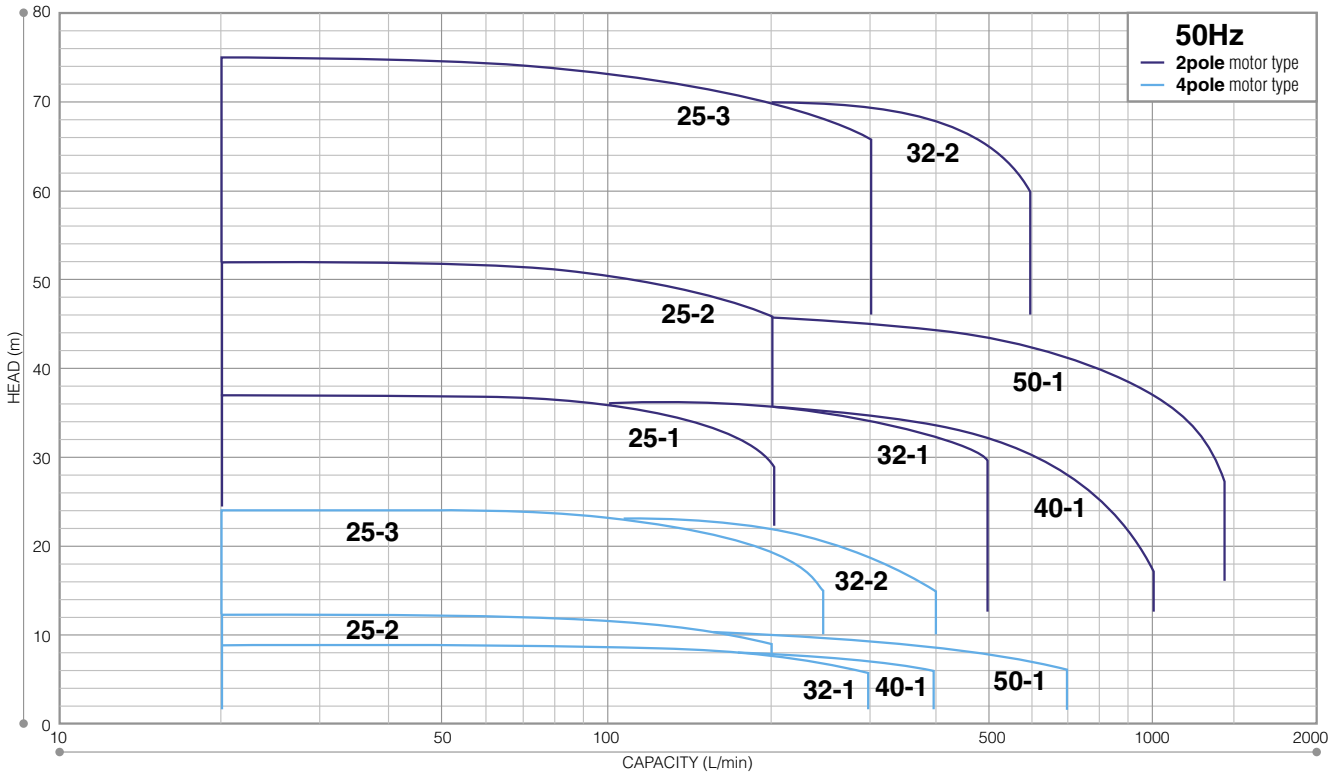

### Iwaki dry running protector DR series (Option)

Model DR is electric current sensing type dry running protector. It detects the decreased load current (lower limit) to stop the pump when it runs dry or runs with air sucking in. It can detect over-load, too.



DR-20

#### Specification

Model	DR-20		50/60Hz
Motor power	380 to 440V		
Applied motor	0.75 to 15kW		
Power	V	200 to 240V 10% shingle phase	
45-65Hz	Input	3.5W	
Detective current	0.5 to 32.0A		
Current transformer(CT)	Built-in		
Current range	Auto	4.4/17.6/32A	
	Manual	2.2/4.4/8.8/11/17.6/26.4/32A	
Ambient	Temperature:0 to 40°C Humidity:RH40 to 85%		
Outer dimension	D80 X W153 X H110		

- Current figure to be set is indicated on LCD.
- Both top/bottom figures can be set.
  - Top:Over-load
  - Bottom:Dry running, air sucking-in operation, operation with suction side closed
- Built-in current transformer
- DIN rail mounting

# Dimensions

## 2 pole motor type

Flange motor type  
(with base type)

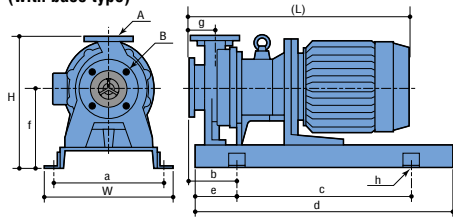

Flange motor type  
(without base type)

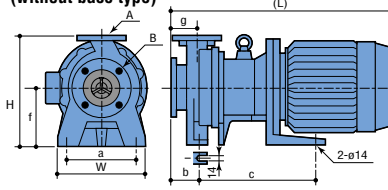

Long coupling type

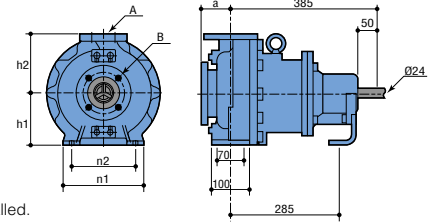

Note: The dimensions may differ with the type of motor installed.

### Flange motor type with base

Model	Motor	W	H	(L)	a	b	c	(d)	(e)	f	g	h	A	B	Mass kg Less motor
MDM25-1	1.5kW	400	400	515	350	135	480	710	115	240	80	4-ø19	25	40	63
	2.2kW			625											89
	4.0kW			689											92
MDM25-2	5.5kW	400	430	711	350	150	540	800	130	250	80	4-ø19	25	40	100
	7.5kW			864											135
	11kW			884											140
MDM25-3	15kW	480	485	625	430	192	600	900	150	320	102	4-ø19	25	40	84
	4.0kW			689											87
	5.5kW			711											105
MDM32-1	7.5kW	400	410	689	350	150	540	800	130	250	80	4-ø19	32	50	87
	5.5kW			689											105
	7.5kW			689											140
MDM32-2	11kW	400	430	842	430	170	600	900	150	320	80	4-ø19	32	50	140
	15kW			884											140
	4.0kW			625											85
MDM40-1	5.5kW	400	410	689	350	150	540	800	130	250	80	4-ø19	40	65	88
	7.5kW			689											88
	15kW			709											96
MDM50-1	5.5kW	400	430	709	350	170	540	800	130	250	100	4-ø19	50	80	96
	7.5kW			709											96
	11kW			862											129

in mm

### Flange motor type without base

Model	Motor	W	H	(L)	a	b	c	f	g	A	B	Mass kg Less motor
MDM25-1	1.5kW	180	310	515	130	100	150	150	80	25	40	37
	2.2kW			625								62
	4.0kW			689								65
MDM25-2	5.5kW	280	360	689	220	90	365	180	80	25	40	65
	7.5kW			689								65
	11kW			711								70
MDM25-3	15kW	280	345	711	220	112	365	180	102	25	40	70
	4.0kW			625								57
	5.5kW			689								60
MDM32-1	7.5kW	280	340	689	220	90	365	180	80	32	50	60
	5.5kW			689								60
	7.5kW			689								75
MDM32-2	11kW	280	360	689	220	90	365	180	80	32	50	75
	15kW			842								90
	4.0kW			625								58
MDM40-1	5.5kW	280	340	689	220	90	365	180	80	40	65	61
	7.5kW			689								61
	15kW			709								69
MDM50-1	5.5kW	280	360	709	220	110	365	180	100	50	80	69
	7.5kW			709								69
	11kW			862								82

in mm

### Long coupling type without base, coupling, motor

Model	a	h1	h2	n1	n2	A	B	Mass kg Less motor
MDM32-1601	80	132	160	240	190	32	50	70
MDM32-2002		160	180			32	50	80
MDM40-1601		132	160			40	65	70
MDM50-1601	100	160	180	265	212	50	80	80

in mm